

Article number: 25075262002

Description: ICME Single-phase motor MD80 B2 0,75KW
2 - 2800 rpm 1x230 Volt 50Hz B3 with starting & running capacitor

Measures

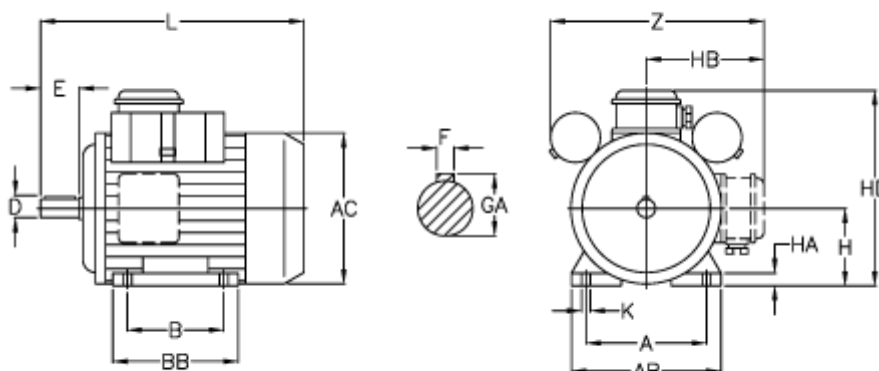

A = 125	H = 80
AB = 155	HA = 13
AC = 156	HB = 122
B = 100	K = 9
D = 19	L = 305
E = 40	Z = 230
F = 6	
GA = 21.5	